

ALFA 177

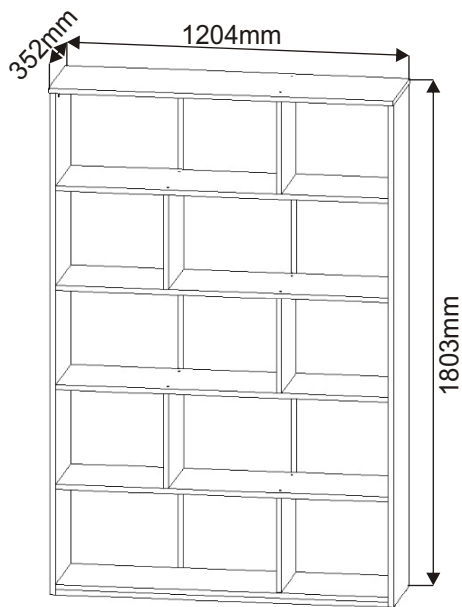

Úhelník 73x31x15 2x 	Excentr 16x 	Šroub excentru 16x 	Kluzáky 6x 	Hřebík 132x
Kolík 35mm 36x 	Lepidlo 40ml 1x 	Konfirmát 50mm 20x 	Hmoždinka ø10 2x 	Krytka velká 30x
		Vrut 4x20 4x 	Vrut 4x30 8x 	Vrut 5x50 2x
			H lišta 334mm 5x 	

1.

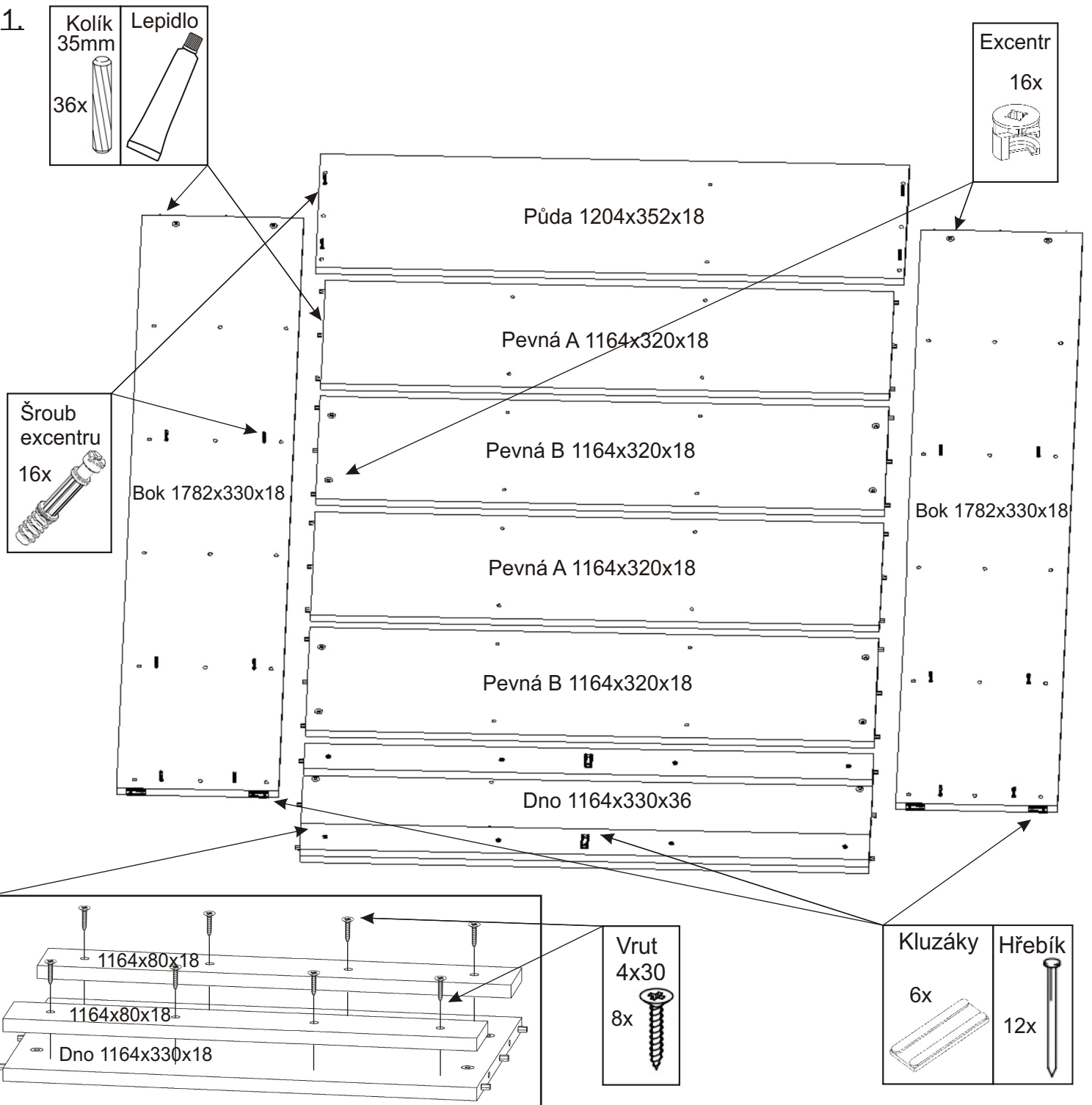

2.

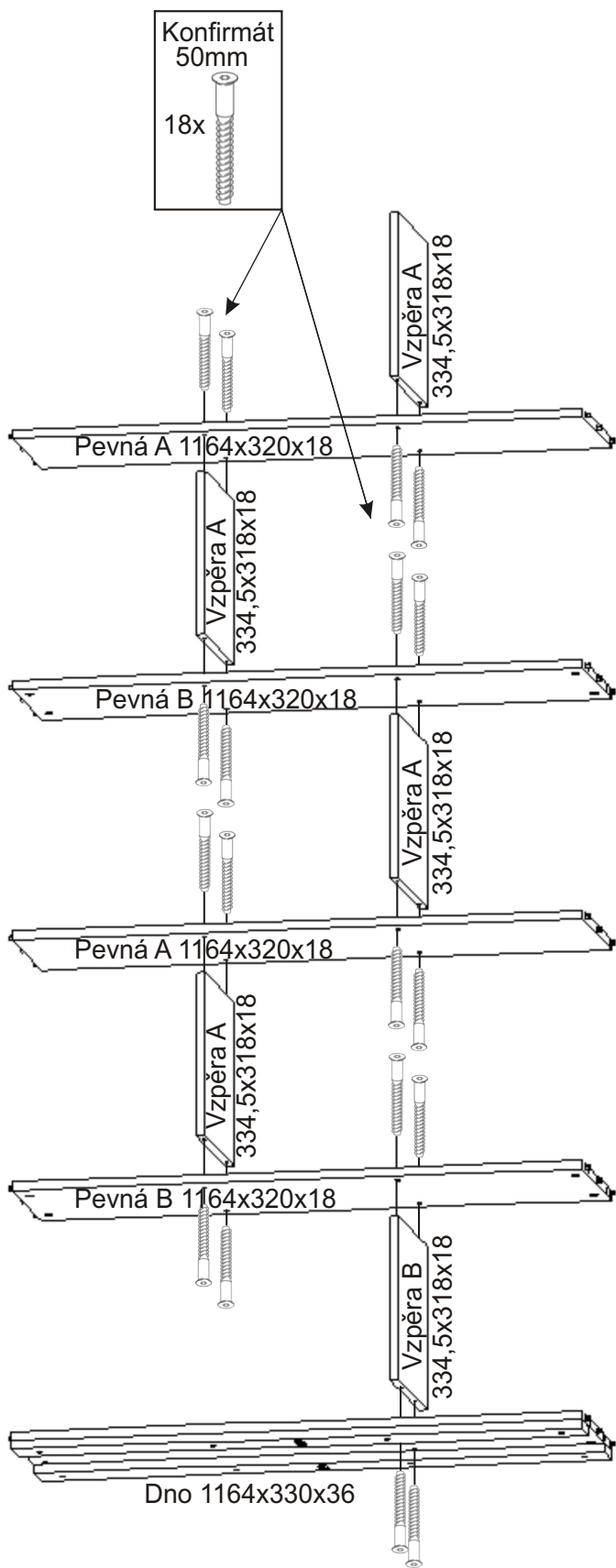

3.

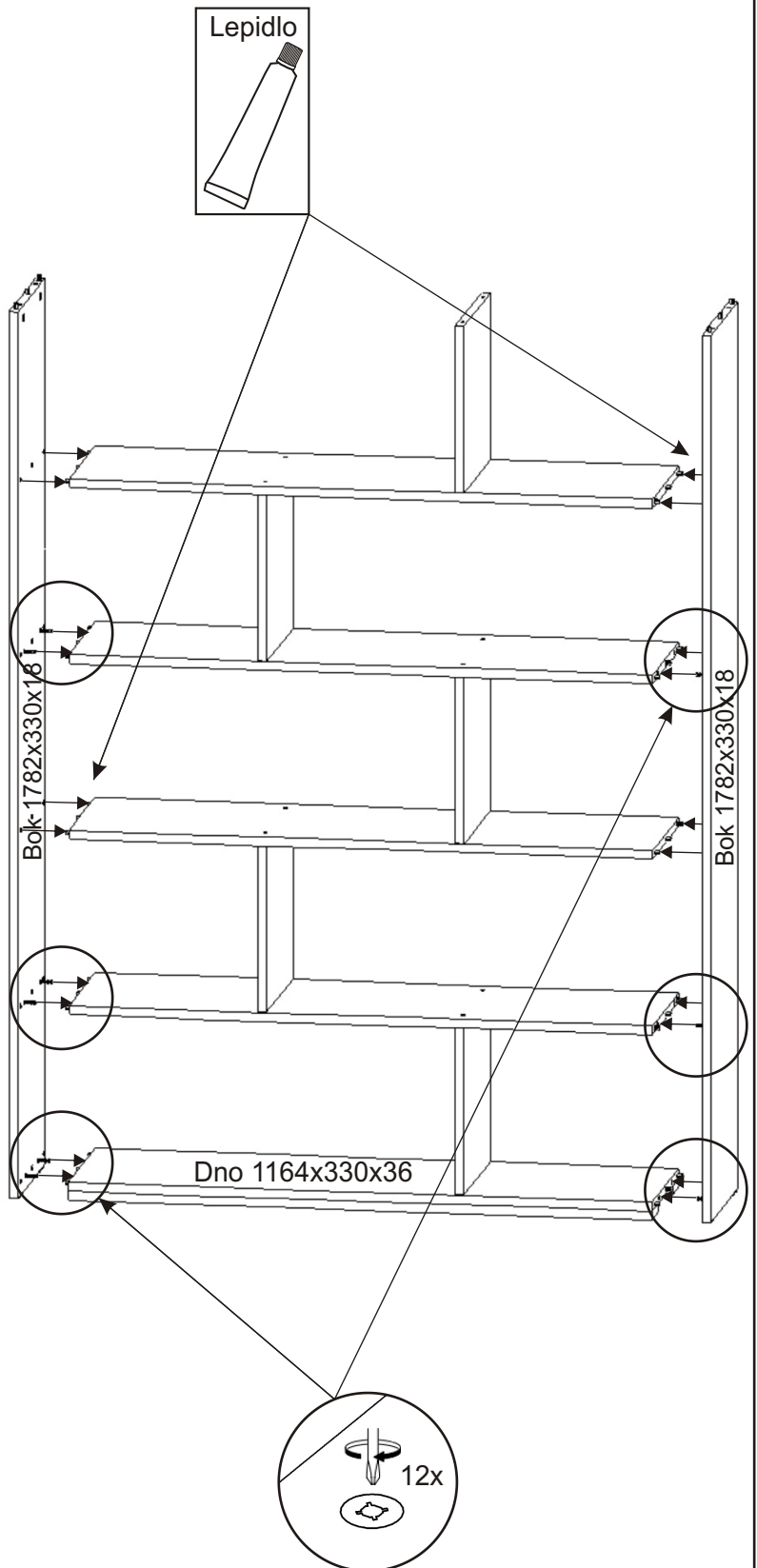

4.

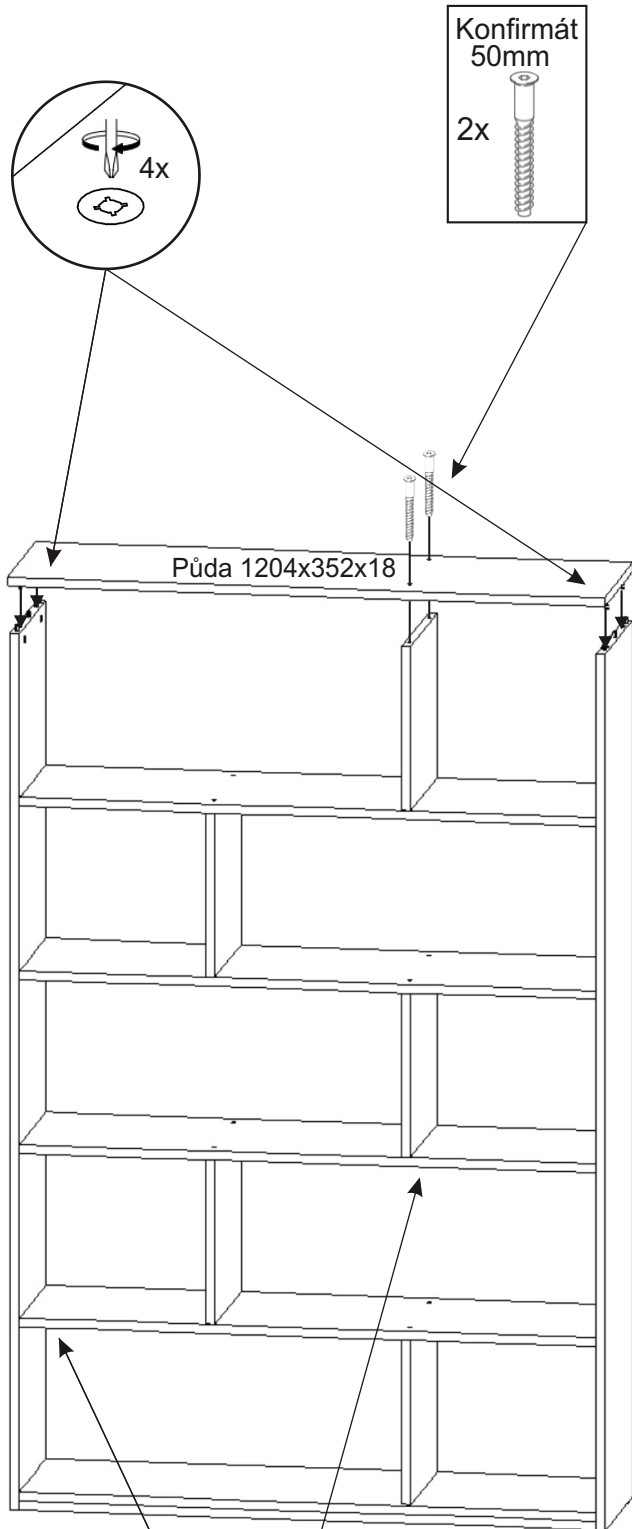

5.

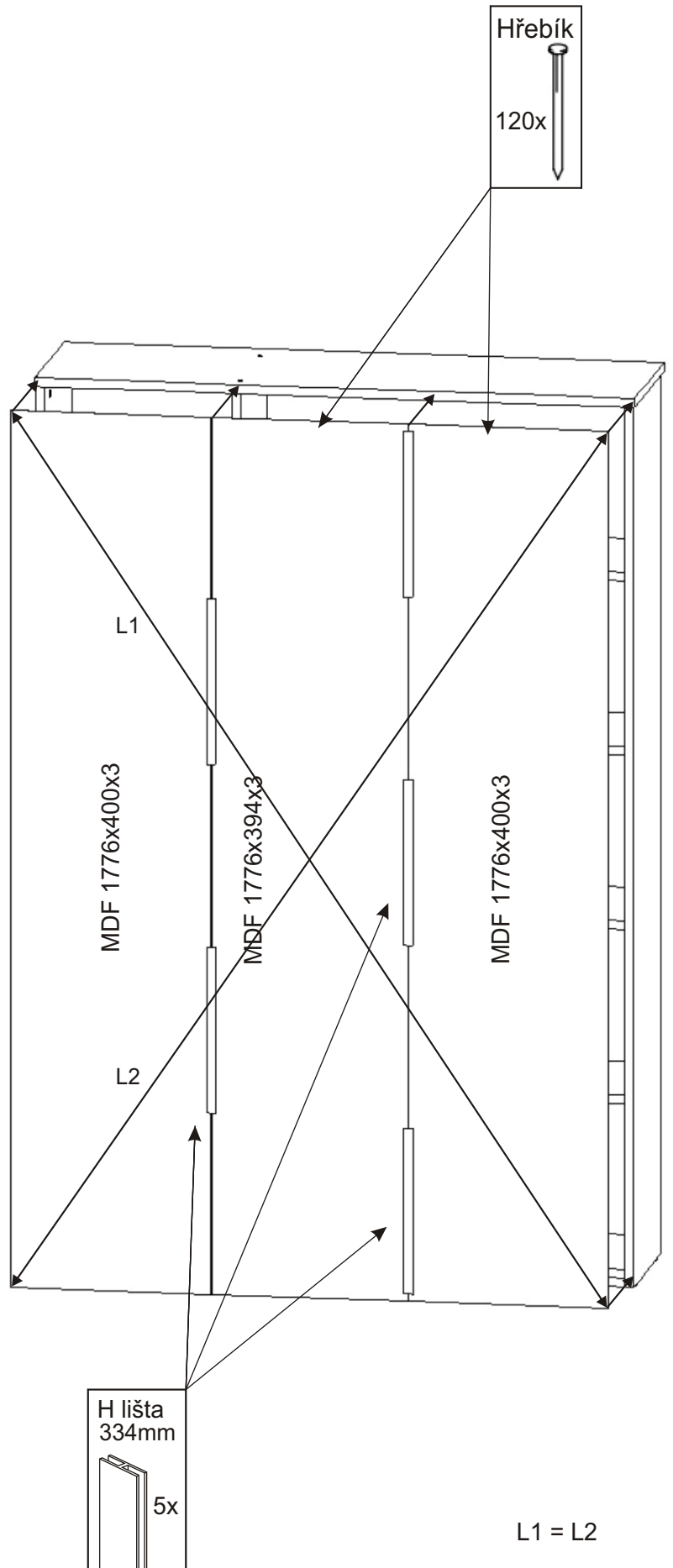

6.

Skříň doporučujeme kvůli nebezpečí převržení připevnit ke zdi pomocí úhelníků. Skříň přisuneme ke zdi na místo kde bude umístěna a označíme otvory pro hmoždinky. Navrtáme otvory pro hmoždinky a připevníme dodanými vruty. (Námi dodávané hmoždinky jsou vhodné pro stěny z plných materiálů.)

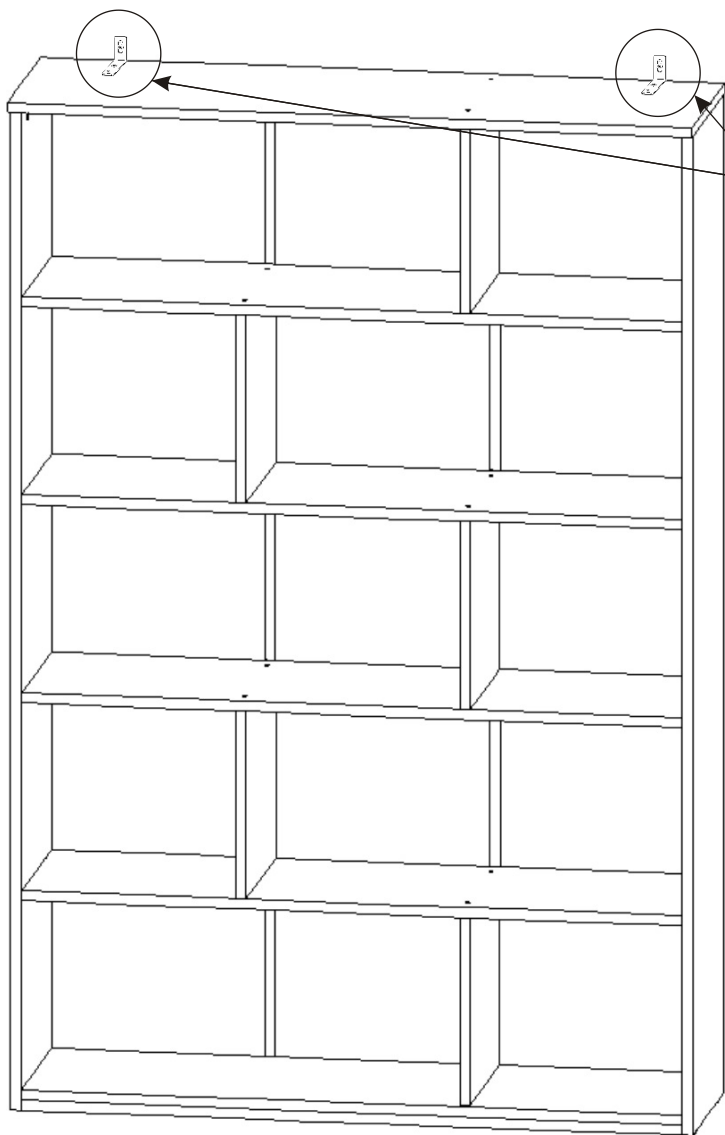

6.1.

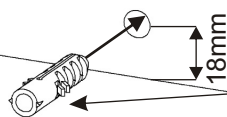

Hmoždinka

ø10

2x



Vrut
4x20

4x



6.2.

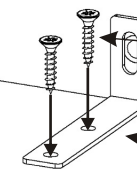

Úhelník
73x31x15

2x

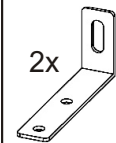

6.3.

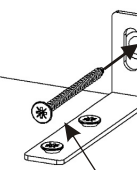

Vrut
5x50

2x

